



## 客製服務 - 材料提供需知



## 客製服務

寺日工作室透過研究「服裝再製」技術，解決舊衣過盛帶來的環境問題。作為一間社會企業，我們在偏鄉地區建立設計工作室，為弱勢族群、二度就業婦女提供職業培訓及工作機會，培養她們成為專業的「服裝再製師」。

因為珍惜每一件衣服的心，我們推出客製服裝再製服務，客人把舊衣送來，「服裝再製師」會根據客人的需求，重新改造成全新的時尚單品，讓舊衣有再一次被喜愛的機會。

## 綜合建議

## 不適合用作再製材料的衣物



真皮或人造皮材質



蕾絲材質



輕薄紗材質



絨毛類材質



毛衣及毛線衫



內衣褲



有破洞的衣物



太短太小件的衣物

## 適合用作再製材料的衣物



T恤衫



大衣外套



牛仔褲



格子襯衫



半身裙



襯衫裙



連身裙



西裝外套

還有很多……

## 個別款式建議



輕便托特包

#1906005



- + 皮革類、蕾絲薄紗類、毛衣或毛線衫、毛絨類不適合
- + 內衣褲等貼身衣物不適合
- + 有破洞衣物不適合
- + 太短或太小件(例如嬰兒或童裝、熱褲、短裙)不適合



- + 有印花的T恤衫是很好的選擇, 但請注意如果太小件(如女裝S/M碼或男裝S碼), 可能會因為布料不足而無法製作
- + 長褲、裙子、襯衫、外套、風衣、等都很適合

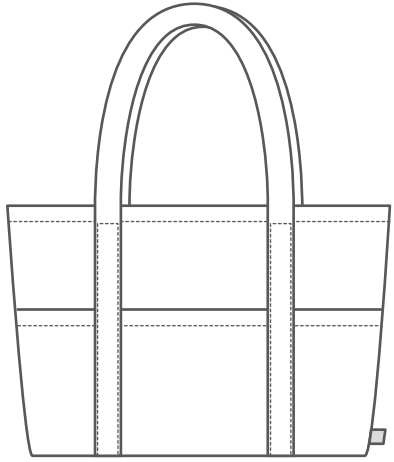

經典五袋包

#1906010



- + 皮革類、蕾絲薄紗類、毛衣或毛線衫、毛絨類不適合
- + 內衣褲等貼身衣物不適合
- + 有破洞衣物不適合
- + 太短或太小件(例如嬰兒或童裝、熱褲、短裙)不適合
- + 針織類(如T恤衫)不適合



- + 任何平織衣物都適合
- + 上衣、長褲、裙子、襯衫、外套、風衣、等都很適合



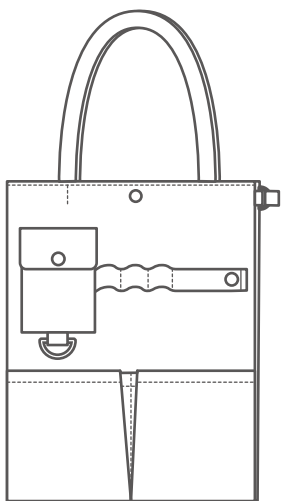

真皮提帶雙面  
收納型托特包

#1906015



- + 皮革類、蕾絲薄紗類、毛衣或毛線衫、毛絨類不適合
- + 內衣褲等貼身衣物不適合
- + 有破洞衣物不適合
- + 太短或太小件(例如嬰兒或童裝、熱褲、短裙)不適合
- + 針織類(如T恤衫)不適合



- + 任何平織衣物都適合
- + 上衣、長褲、裙子、襯衫、外套、風衣、等都很適合

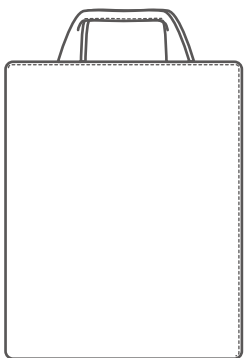

- + 皮革類、蕾絲薄紗類、毛衣或毛線衫、毛絨類不適合
- + 內衣褲等貼身衣物不適合
- + 有破洞衣物不適合
- + 太短或太小件(例如嬰兒或童裝、熱褲、短裙)不適合
- + 針織類(如T恤衫)不適合

## 加厚防撞電腦包

#1906012



- + 任何平織衣物都適合
- + 上衣、長褲、裙子、襯衫、外套、風衣、等都很適合

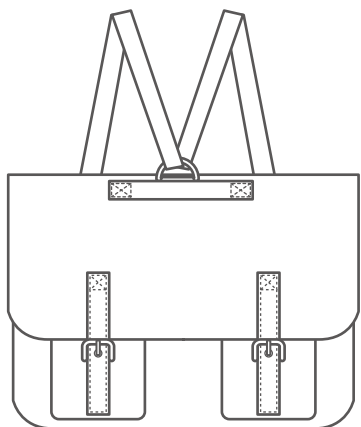

- + 皮革類、蕾絲薄紗類、毛衣或毛線衫、毛絨類不適合
- + 內衣褲等貼身衣物不適合
- + 有破洞衣物不適合
- + 太短或太小件(例如嬰兒或童裝、熱褲、短裙)不適合
- + 針織類(如T恤衫)不適合

## 英倫風兩用背包

#1906016



- + 任何平織衣物都適合
- + 上衣、長褲、裙子、襯衫、外套、風衣、等都很適合

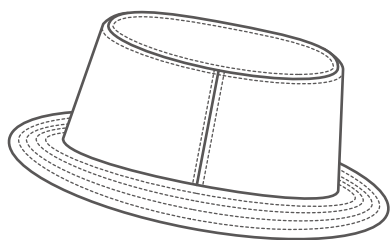

漁夫帽

#1906008



- + 皮革類、蕾絲薄紗類、毛衣或毛線衫、毛絨類不適合
- + 內衣褲等貼身衣物不適合
- + 有破洞衣物不適合
- + 太短或太小件(例如嬰兒或童裝、熱褲、短裙)不適合
- + 針織類(如T恤衫)不適合



- + 任何平織衣物都適合
- + 上衣、長褲、裙子、襯衫、外套、風衣、等都很適合

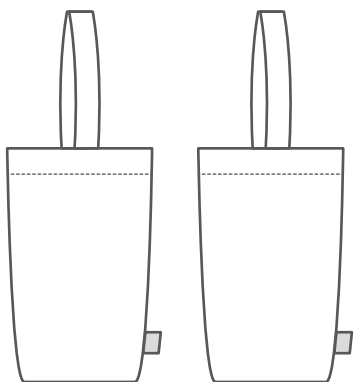

- + 皮革類、蕾絲薄紗類、毛衣或毛線衫、毛絨類不適合
- + 內衣褲等貼身衣物不適合
- + 有破洞衣物不適合
- + 太短或太小件(例如嬰兒或童裝、熱褲、短裙)不適合
- + 針織類(如T恤衫)不適合

## 飲料提袋 2件

#1906006



- + 任何平織衣物都適合
- + 上衣、長褲、裙子、襯衫、外套、風衣、等都很適合

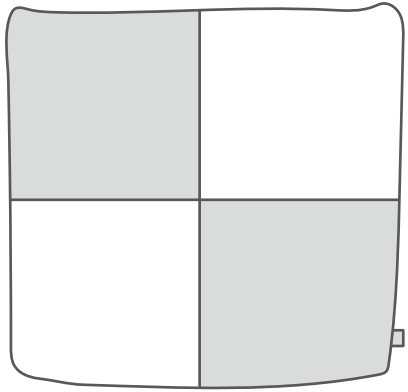

## 拼接抱枕套

#1906003



- + 皮革類、蕾絲薄紗類、毛衣或毛線衫、毛絨類不適合
- + 內衣褲等貼身衣物不適合
- + 有破洞衣物不適合
- + 太短或太小件(例如嬰兒或童裝、熱褲、短裙)不適合



- + 有印花的T恤衫是很好的選擇, 但請注意如果太小件(如女裝S/M碼或男裝S碼), 可能會因為布料不足而無法製作
- + 長褲、裙子、襯衫、外套、風衣、等都很適合

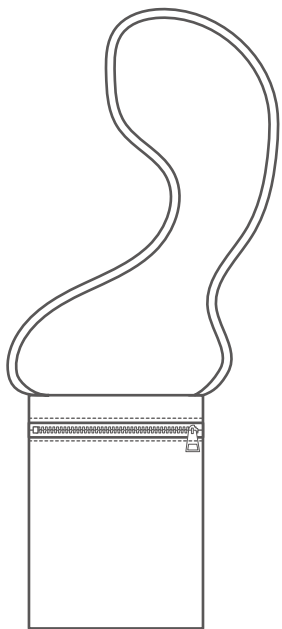

- + 皮革類、蕾絲薄紗類、毛衣或毛線衫、毛絨類不適合
- + 內衣褲等貼身衣物不適合
- + 有破洞衣物不適合
- + 太短或太小件(例如嬰兒或童裝、熱褲、短裙)不適合
- + 針織類(如T恤衫)不適合

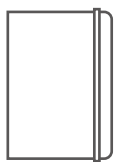

- + 任何平織衣物都適合
- + 長褲、裙子、襯衫、外套、風衣、等都很適合

旅行組(護照夾+  
行李牌+貼身小袋子)

#1906011

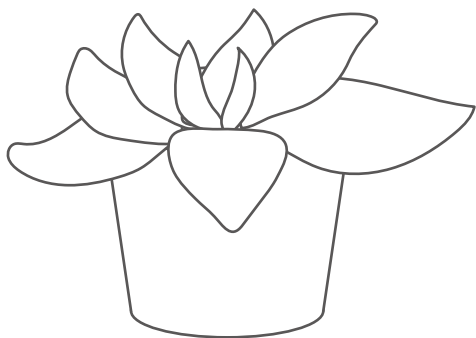

- + 皮革類、蕾絲薄紗類、毛衣或毛線衫、毛絨類不適合
- + 內衣褲等貼身衣物不適合
- + 有破洞衣物不適合
- + 太短或太小件(例如嬰兒或童裝、熱褲、短裙)不適合

## 布藝植物【虎尾蘭】

#1906007



- + 長褲、裙子、襯衫、外套、風衣、等都很適合



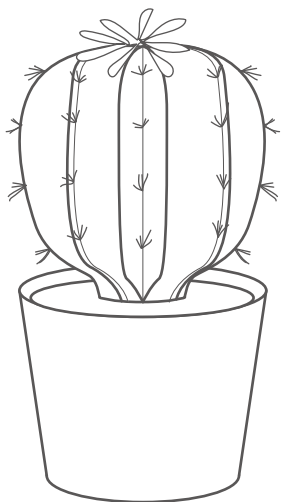

- + 皮革類、蕾絲薄紗類、毛衣或毛線衫、毛絨類不適合
- + 內衣褲等貼身衣物不適合
- + 有破洞衣物不適合
- + 太短或太小件(例如嬰兒或童裝、熱褲、短裙)不適合

## 布藝植物【仙人掌球】

#1906009



- + 上衣、長褲、裙子、襯衫、外套、風衣、等都很適合

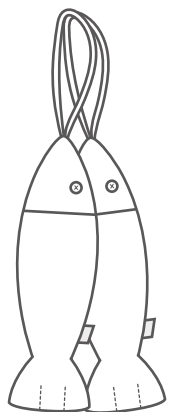

貓草魚造型玩具 2件

#1906001



- + 皮革類、蕾絲薄紗類、毛衣或毛線衫、毛絨類不適合
- + 內衣褲等貼身衣物不適合
- + 有破洞衣物不適合
- + 太短或太小件(例如嬰兒或童裝、熱褲、短裙)不適合
- + 太薄容易被咬破的材質
- + 針織類(如T恤衫)不適合



- + 牛仔褲、厚實外套、平織厚布料衣物也很合適

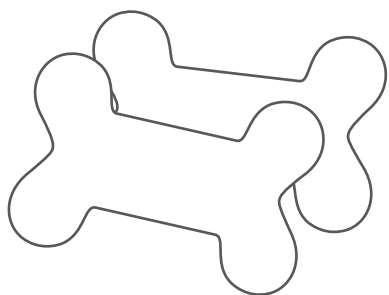

- + 皮革類、蕾絲薄紗類、毛衣或毛線衫、毛絨類不適合
- + 內衣褲等貼身衣物不適合
- + 有破洞衣物不適合
- + 太短或太小件(例如嬰兒或童裝、熱褲、短裙)不適合
- + 太薄容易被咬破的材質
- + 針織類(如T恤衫)不適合

狗骨頭玩具 2件

#1906002



- + 牛仔褲、厚實外套、平織厚布料衣物也很合適

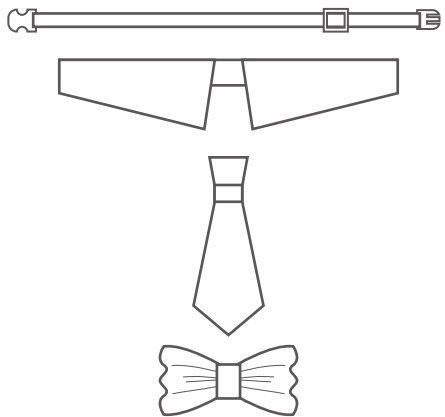

## 四合一寵物領圈組合

#1906004



- + 皮革類、蕾絲薄紗類、毛衣或毛線衫、毛絨類不適合
- + 內衣褲等貼身衣物不適合
- + 有破洞衣物不適合
- + 太短或太小件(例如嬰兒或童裝、熱褲、短裙)不適合
- + 針織類(如T恤衫)不適合



- + 任何平織衣物都適合
- + 褲子、裙子、襯衫、外套等都很適合



  aglassoftime

<https://aglassoftime.com/>

桃園市大溪區仁和路二段190巷478號